

Varenummer: 20055555
 Beskrivelse: E+G Kobling for radial forskydning
 GN 240-M16x1,5-B

Mål

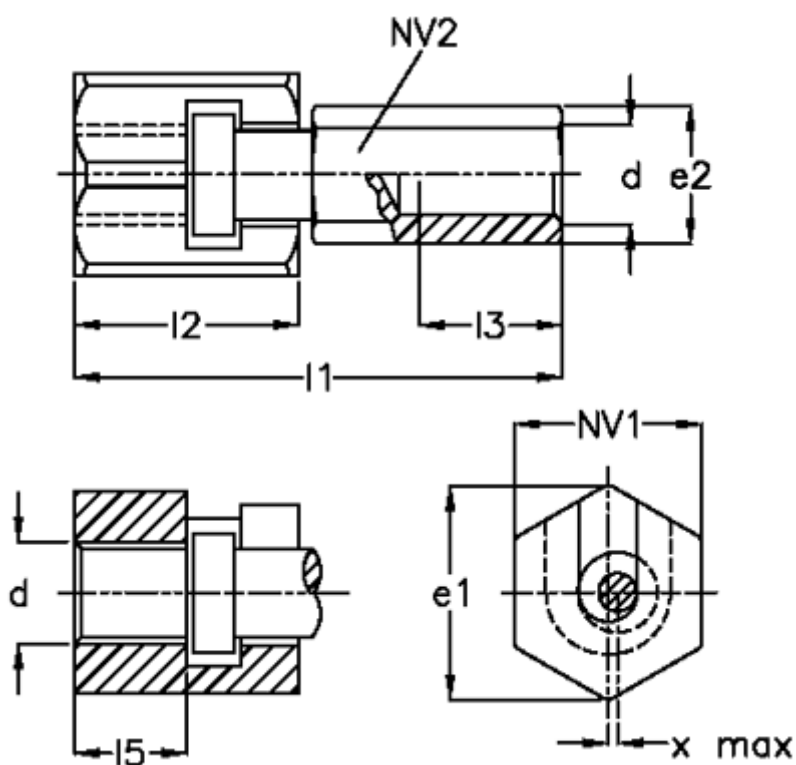

d	= M 16x1,5	Max træk-skub kraft N = 18000
e1	= 39.0	NV 1 = 36
e2	= 27.0	NV 2 = 24
l1	= 83.5	
l2	= 42.0	
l3	= 25.0	
l5 +1	= 23.0	
Max forskydning = 1.0		